













Cruzber S.A., ES-A14018311
P.I. Las Salinas II, E-14960 Rute
www.cruzber.com





Código Code Code Kode	932-384		
	Lv 7 2015 - r7		
Lote Lot Lot Lot	03-07	Peso Weight Poids Gewicht	0,98 kg
  			
Kit tipo Kit type Kit type Kit Typ	L		
Código Homologación ECE R 26.03 R 26.03 ECE Type Approval Number	 26 R- 03 3015		

- (E) **Instrucción de montaje**
¡Leer primero!
- (GB) **Assembly instructions**
Read first!
- (F) **Instruction de montage**
Lire en premier!
- (D) **Montageanleitung**
Zuerst lesen!
- (PT) **Instruções de montagem**
Ler primeiro!
- (PL) **Instrukcja montażu**
Najpierw przeczytaj!
- (CZ) **Montážní návod**
Čtěte pozorně!
- (HU) **Szerelési Utasítás**
Először olvassd el!
- (RO) **Instructiuni de montaj**
Intai cititi!
- (HR) **Detaljne upute**
Prvo pročitati!
- (GR) **Διαβάστε προσεκτικά τις**
Οδηγίες Συναρμολόγησης!
- (TR) **Öncelikli montaj:**
Talimatlarını okuyunuz!
- (RU) **Инструкции по монтажу**
Сначала прочитайте!
- (IT) **Istruzioni di montaggio**
Leggere per primo!
- (NL) **Montagehandleiding**
Eerst lezen!
- (SLO) **Navodila za sestavljanje**
Preberite!

- Kit fijación
- Fixation Kit
- Kit fixation
- Stützfuß-Kit
- Kit fixação
- Element mocujący
- Fixační kit
- Rögzítő készlet
- Kit de fixare
- Kit za montažu
- Κιβώτιο (Kit) Επισκευής
- Montaj kiti
- Крепежный комплект
- Kit di fissaggio
- Bevestigingsset
- Kit za pričvrstitev

	1°		
	2°		
			

- (E) **Contenido embalaje:** ¡Verificar!
- (GB) **Package content:** Check!
- (F) **Contenu d'emballage:** Vérifier!
- (D) **Packungsinhalt:** Überprüfen!
- (PT) **Contéudo embalagem:** Verificar!
- (PL) **Zawartość opakowania:** sprawdzić!
- (CZ) **Obsah balení:** Zkontrolujte!
- (HU) **Csomag tartalma:** Ellenőrizd!
- (RO) **Pachetul contine:** Verificati!
- (HR) **Sadržaj paketa:** Provjeri!
- (GR) **Ελέγξτε το περιεχόμενο:** του πακέτου!
- (TR) **Paket içeriğini:** Control ediniz!
- (RU) **Содержание упаковки:** Проверьте!
- (IT) **Contenuto della confezione:** Controllare!
- (NL) **Pakket inhoud:** Controleer!
- (SLO) **Vsebina paketa:** Preverite!

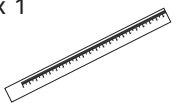
x 1 	x 1 	x 1  (018-041)	x 4  (815-296)
x 4  (813-002)	x 1  (001-820)		

Código
Code
Code
Kode

932-384

Lv 7 2015 - r7



Importante!
Important!
Important!
Wichtig!

- (E)** ¡Este Kit de fijación tiene que usarse con sistemas portacargas Cruz!
- (GB)** This fixation Kit must be used with Cruz roof rack systems!
- (F)** Cet Kit de fixation devra être utilisé avec les systèmes portecharge Cruz!
- (D)** Dieser Stützfuß-Kit muß mit Cruz Dachträgersystemen benutzt werden!
- (PT)** Este Kit de fixação deve ser utilizado com os sistemas porta cargas Cruz!
- (PL)** Niniejszy element mocujący musi być używany z systemami bagażników dachowych firmy Cruz!
- (CZ)** Tento fixační kit musí být používán s nosným systémem Cruz!
- (HU)** Ez a rögzítő készlet csak a Cruz rendszerekkel használható!
- (RO)** Acest Kit de fixare, trebuie utilizat cu sisteme Cruz!
- (HR)** Kit za montažu mora biti korišten uz Cruz sistem krovnog nosača!
- (GR)** Το αξεσουάρ αυτό θα πρέπει να χρησιμοποιείται αποκλειστικά στα συστήματα μπαρών της Cruz!
- (TR)** Bu aksesuar mutlaka Cruz taşıma sistemleriyle kullanılmalıdır!
- (RU)** Крепежный комплект должен быть использован с багажной системой на крышу марки Cruz!
- (IT)** Questo accessorio deve essere usato con i portapacchi Cruz!
- (NL)** Deze bevestigingsset moet worden gebruikt in combinatie met Cruz dakdrager systeem!
- (SLO)** Prečke je potrebno uporabiti s Cruz kiti za pričvrščanje

1

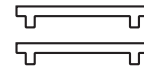

1

2

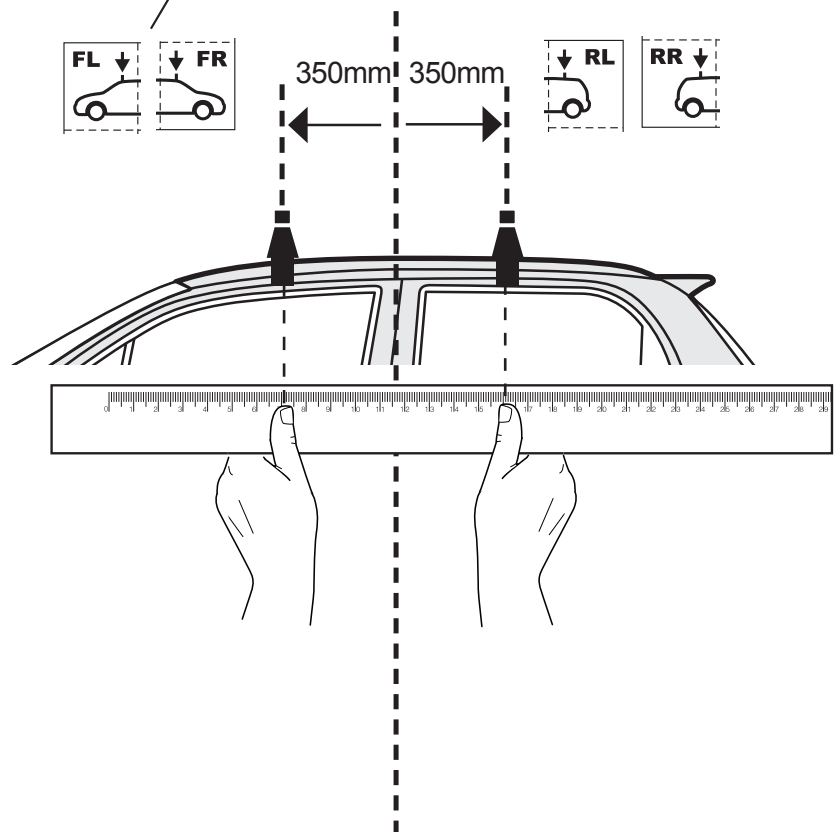

3

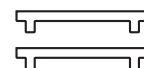

3