



934-208

Lv7 2021-r2

Modelo-model:

Kit soportes LCV

Lote-Lot-Lot-Lot:

01-18

Peso-Weight-Poids-Gewicht:

1,12 kg

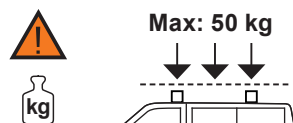
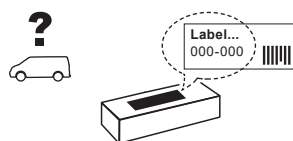

CEE - EEC type approval:

(E9) 26 R- 03 3022



CRUZBER SA
ES-A14018311
P.I. Las Salinas II
14960 - Rute - Spain
www.cruzber.com

- | | | |
|--------------|---|-------------------------|
| (E) | Instrucción de montaje
¡Leer primero! | Kit fijación |
| (GB) | Assembly instructions
Read first! | Fixation Kit |
| (F) | Instruction de montage
Lire en premier! | Kit fixation |
| (D) | Montageanleitung
Zuerst lesen! | Stützfuß-Kit |
| (PT) | Instruções de montagem
Ler primeiro! | Kit fixação |
| (PL) | Instrukcja montażu
Najpierw przeczytaj! | Element mocujący |
| (CZ) | Montážní návod
Čtěte pozorně! | Fixační kit |
| (HU) | Szerelési Utasítás
Először olvasd el! | Rögzítő készlet |
| (RO) | Instructiuni de montaj
Intai cititi! | Kit de fixare |
| (HR) | Detaljne upute
Prvo pročitati! | Kit za montažu |
| (GR) | Διαβάστε προσεκτικά τις
Οδηγίες Συναρμολόγησης! | Κιβώτιο (Kit) Επισκευής |
| (TR) | Öncelikle montaj:
Talimatlarını okuyunuz! | Montaj kiti |
| (RU) | Инструкции по монтажу
Сначала прочитайте! | Крепежный комплект |
| (I) | Istruzioni di montaggio
Leggere per primo! | Kit di fissaggio |
| (NL) | Montagehandleiding
Eerst lezen! | Bevestigingsset |
| (SLO) | Navodila za sestavljanje
Preberite! | Kit za pričvrstitev |



1.



(E) Contenido embalaje: ¡Verificar!

(GB) Package content: Check!

(F) Contenu d'emballage: Vérifier!

(D) Packungsinhalt: Überprüfen!

(PT) Contéudo embalagem:
Verificar!

(PL) Zawartość opakowania:
sprawdź!

(CZ) Obsah balení: Zkontrolujte!

(HU) Csomag tartalma: Ellenőrizd!

(RO) Pachetul contine: Verificati!

(HR) Sadržaj paketa: Provjeri!

(GR) Ελέγξτε το περιεχόμενο του
πακέτου!

(TR) Paket içeriğini: Kontrol ediniz!

(RU) Содержание упаковки:
Проверьте!

(I) Contenuto della confezione:
Controllare!

(NL) Pakket inhoud: Controleer!

(SLO) Vsebina paketa: Preverite!

x1



x2

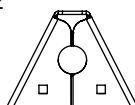

(500)

x2

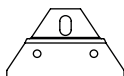

(820)

x2



2x (012-232)

x2

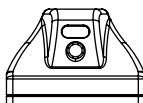

(813-073)

x3



1x (805-042)

1x (810-098)

1x (810-180)

2. 

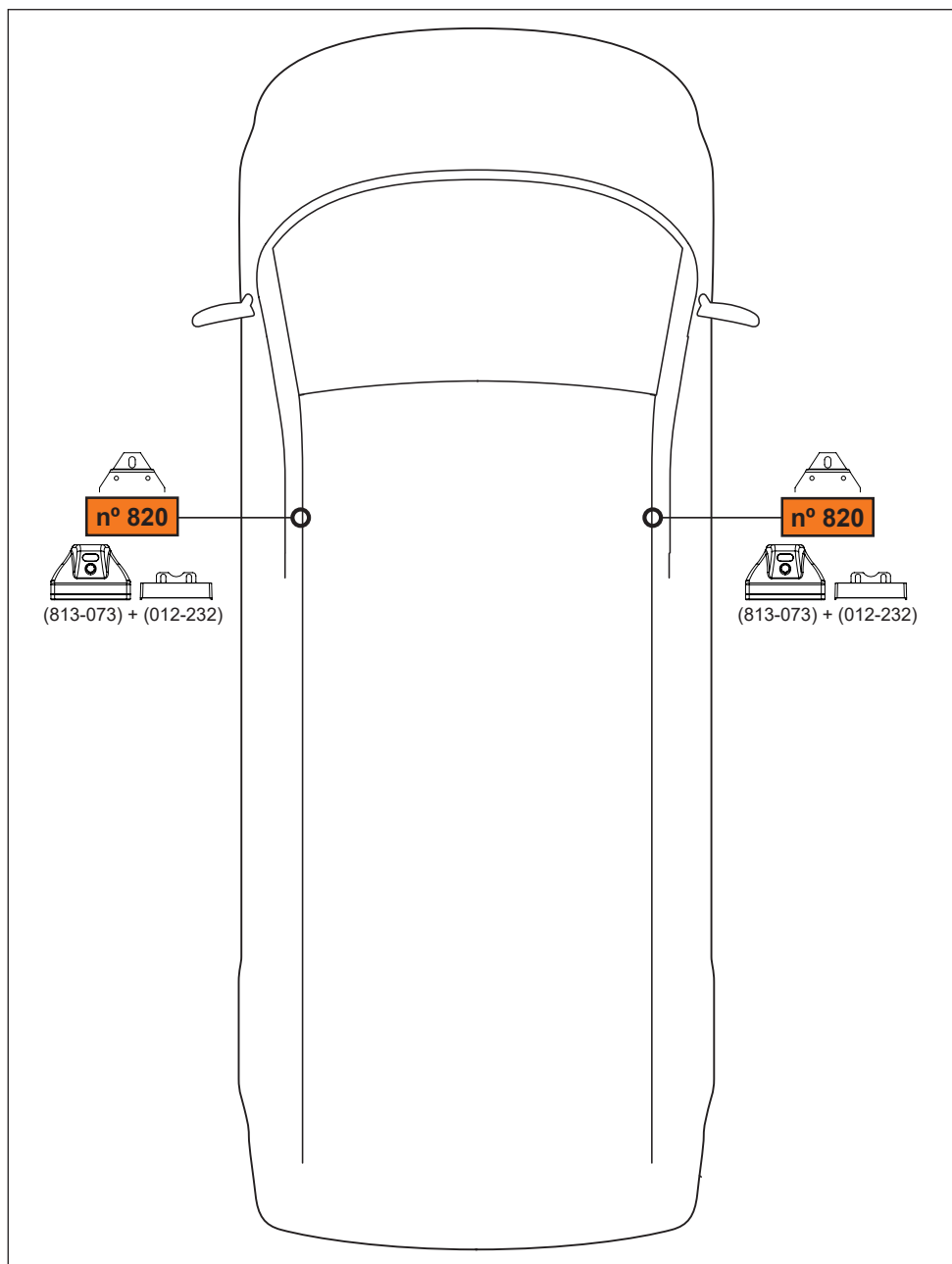

3. 

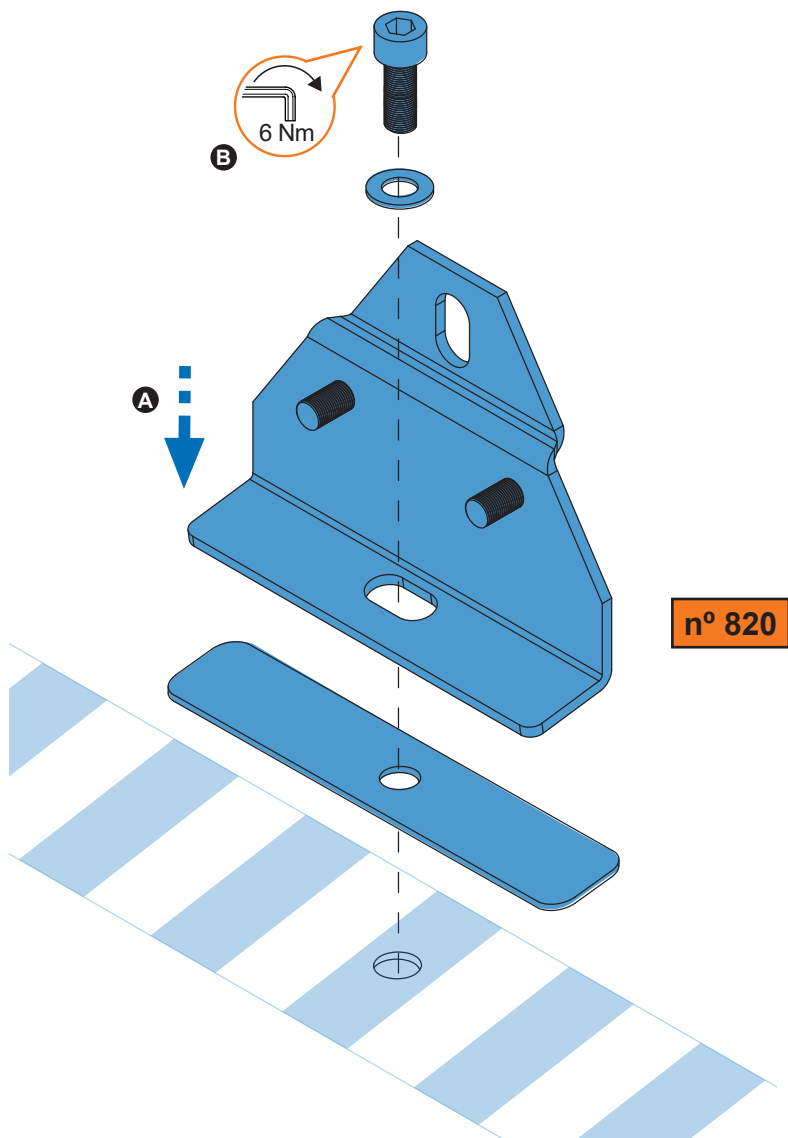

4. 

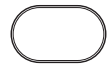

50x30 mm

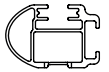

52x35 mm
Aluminium

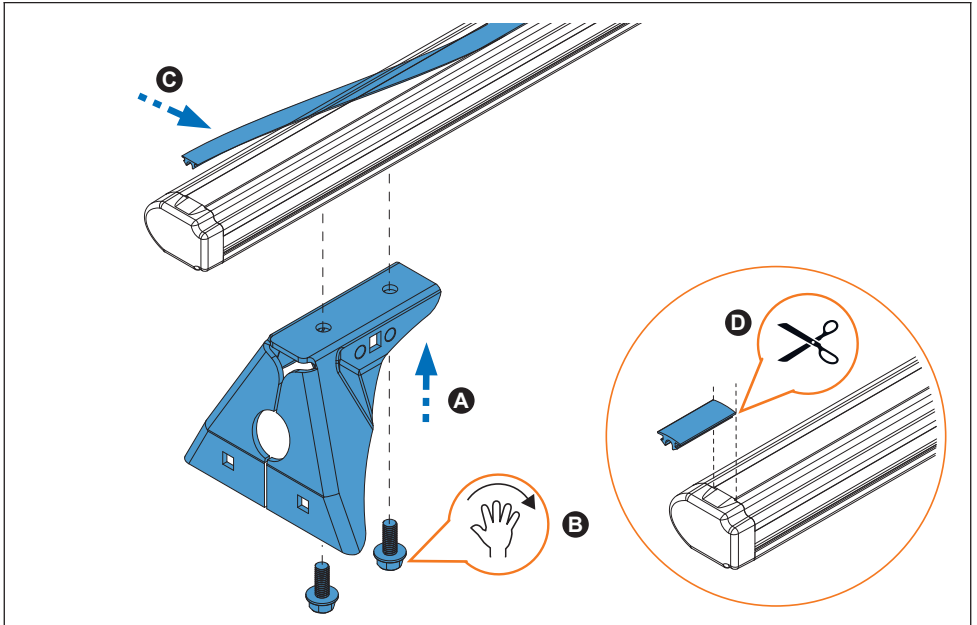
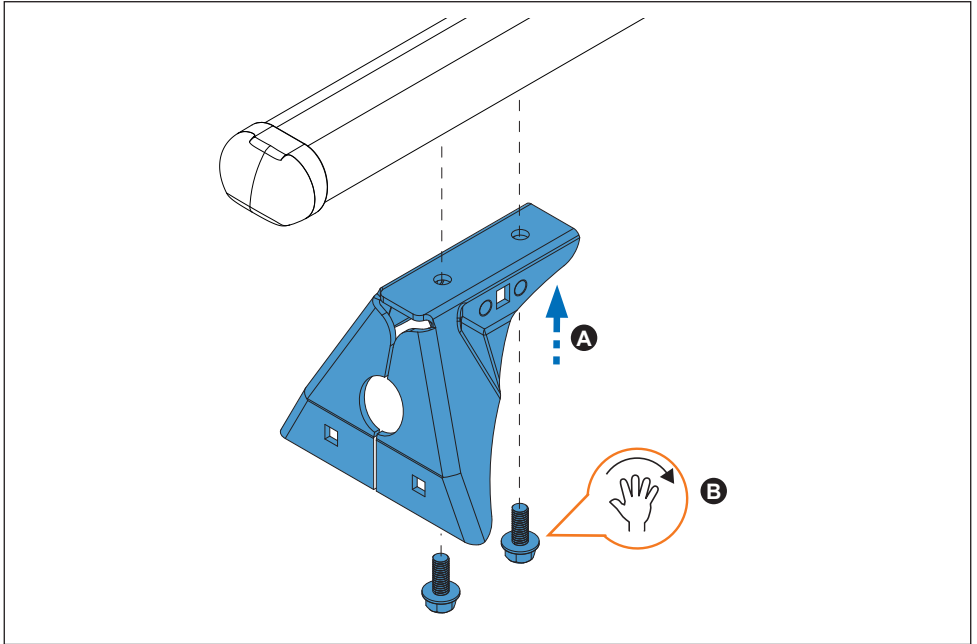

5. 



50x30 mm

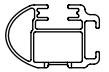

52x35 mm
Aluminium

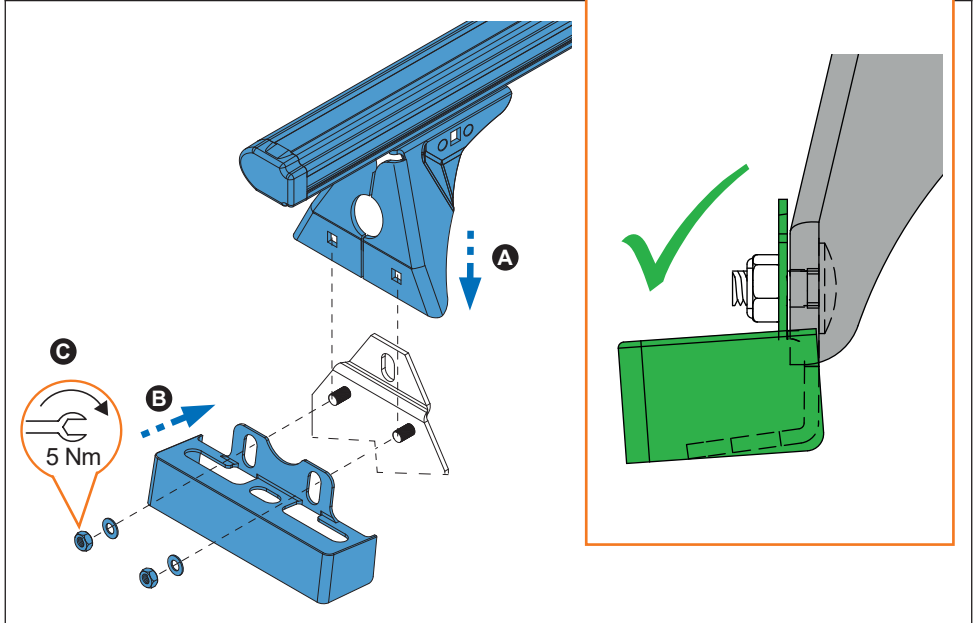
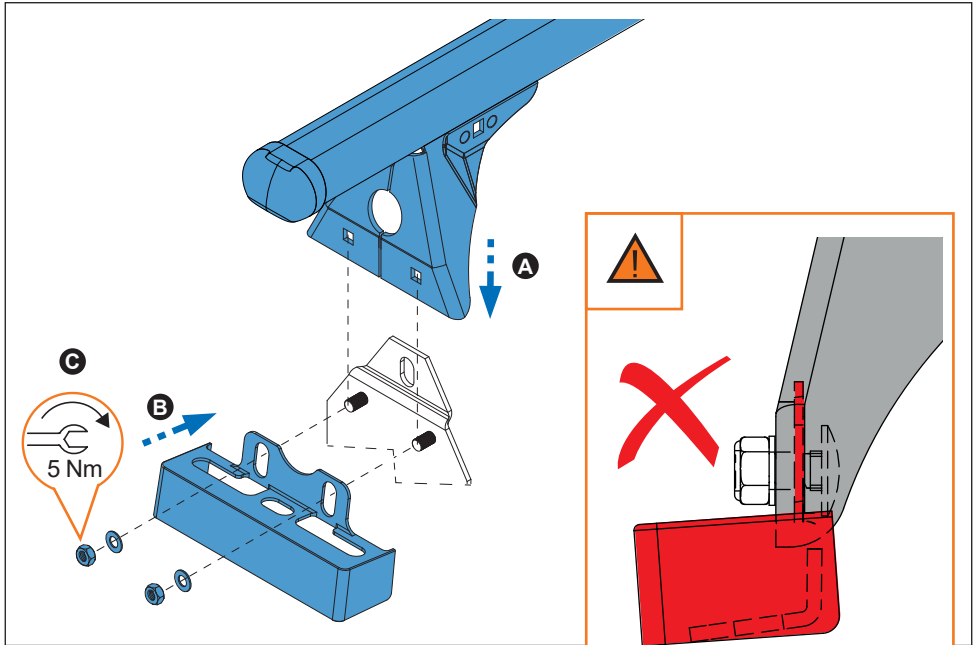

6. 

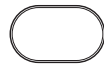

50x30 mm

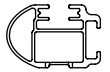

52x35 mm
Aluminium

